



XP3-16 series integrated PLC&HMI

User manual

Xinje Electronic Co., Ltd

No. PH C 04 20101217 3.3

This manual includes some basic precautions which you should follow to keep you safe and protect the products. These precautions are underlined with warning triangles in the manual. About other manuals that we do not mention please follow basic electric operating rules.

Precautions		Please follow the precautions. If not, it may lead the control system incorrect or abnormal, even cause fortune lose.
--------------------	---	---

Correct Application		The models could only be used according to the manual, and an only be used along with the peripheral equipments recognized or recommended by Xinje Electronic. They could only work normally in the condition of be transported, kept and installed correctly, also please operate and maintain them according to the recommendation.
----------------------------	---	---

Xinje Electronic Co., Ltd. Copyright reserved
Without exact paper file allowance, copy, translate or using the manual is not allowed. Disobey this, people should take the responsibility of loss. We reserve all the right of expansions and their design patent.

Duty Declare
We have checked the manual, its content fits the hardware and software of the products. As mistakes are unavoidable, we couldn't promise all correct. However, we would check the data in the manual frequently, and in the next edition, we will correct the necessary information. Your recommendation would be highly appreciated.

Catalog

1	XP3-16 SERIES INTRODUCTION.....	1
1-1.	INTRODUCTION	1
1-1-1.	<i>Characteristics</i>	1
1-1-2.	<i>Name rule</i>	1
1-2.	GENERAL SPECIFICATION	2
1-2-1.	<i>Product specification</i>	2
1-2-2.	<i>Special function</i>	4
1-3.	PART INTRODUCTION	5
1-3-1.	<i>Structure</i>	5
1-3-2.	<i>Function buttons</i>	6
1-3-3.	<i>Terminals</i>	6
1-3-4.	<i>Download and communication port</i>	7
1-4.	DIMENSION	7
2	I/O AND WIRING	9
2-1.	INPUT SPEC.....	9
2-2.	RELAY OUTPUT.....	11
2-3.	TRANSISTOR OUTPUT	13
3	PLC AND HMI PROGRAMMING.....	14
3-1.	PLC PROGRAMMING	14
3-2.	INSTRUCTIONS.....	15
3-2-1.	<i>basic instructions</i>	15
3-2-2.	<i>Application instructions</i>	17
3-2-3.	<i>Special instructions</i>	21
3-3.	HMI PROGRAMMING.....	23
3-3-1.	<i>Make a project</i>	23
3-3-2.	<i>Tools and parts</i>	25
	APPENDIX 1 SPECIAL AUXILIARY REGISTER	27
	APPENDIX 2 SPECIAL DATA REGISTER	35
	APPENDIX 3 SPECIAL FLASH REGISTER	41

Preface

Thank you for purchasing Xinje XP3-16 series integral industrial controller, please read the manual before operating.

Manual purpose

- This manual provides user with the guide of using and operating our product, it includes the product characteristics, spec explanation, using method, etc.
- This manual contains product summarization, exterior layout, PLC program, and HMI editing. The details please refer to XC series PLC manual and TH series HMI manual.
- Summarization: introduce the product characteristics, specs, dimension, installation.
- Exterior layout: introduce the product power spec, in-out layout.
- PLC program: introduce how to program in PLC.
- HMI picture: introduce how to edit picture in TH.
- Exterior extension: introduce extension ability of the product.

Suitable people

This manual aims to below users:

- Terminal user
- Debugging person
- Technology support person

Make sure you have read the safety notice before operating.

Scope

This manual applies to the XP3-16 series integral industrial controller.

Tele-document

Xinje provides user with press document and tele-document:

- User CD
Contained software, manual and application examples
- Xinje website
Welcome to www.xinje.com download center to find electronic document.

Contact us

If you have any questions, please contact us.

Tel: 86-0510-85134136

Fax: 86-0510-85111290

Address: 4th Floor, Building 7, Originality Industrial Park, Liyuan
Development Zone, Wuxi City, Jiangsu province, China

Safety notes

Read the manual carefully before operating. Be aware of the safety and correct operation. The content below is focus on XP3-16 series products only.

Please safekeeping the manual, put in somewhere easy to get and read and give the manual to final user.

⊙ Notice items ⊙



ATTENTION

- Do not put the wire close to cable, keep 10cm distance at least.
- Do not change the inside module of product or it may cause fault, error action, loss, fire.
- When it smelly or noisy, cut the power immediately (short tweet after power on is normal).
- Do not press the screen with pen, screwdriver or other sharp tools, it may cause screen break or error.
- For installing the product, tighten the screws to avoid loose.
- Transport, install, store, assemble and maintain the product accurately to avoid breaking.



DANGEROUSNESS

- Confirm the power voltage and wire connection before turn on the power in order to avoid breaking
- Do not touch the connection point to avoid getting an electric shock
- Do not open the back cover board
- Cut all the power before installation and take-down to avoid error and fault
- Please use in the surrounding the manual stated to avoid accident
- Do not use the product under the condition of high frequency radiation, strong magnetic field to avoid interference

1 XP3-16 series introduction

1-1. Introduction

1-1-1. Characteristics

- Integrated logical control, analog I/O, HMI in one unit

Digital input: 8 points, optical isolation, first 2 channels are high speed opto-isolator, others are general opto-isolator

Digital output: 8 points, the first channel is transistor output (NPN open collector), others are relay output

Analog extension: enable to expand 2 BD boards, the types includes XP3 -3AD2DA-BD2, XP3 -3AD3PT-BD2, XP3 -3PT-P-BD2, XP3-4AD2DA-BD2, XP3-3TC-P-BD2

- LCD: 192*64 pixels, 3.7 inches, monochrome, use life up to 20000 hours
- Up to 26 function buttons, can be set freely, flexible and accurate
- Support high speed count, high speed pulse, external interruption
- Multi-functional download port: download PLC and HMI program with the same cable
- Compact design, save the space of control cabinet

1-1-2. Name rule

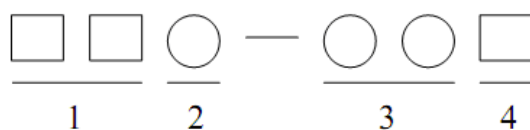

1: Series name	XP3: monochrome LCD
2: PLC type	3: XC3 series
3: I/O points	16: 8 input, 8 output
4: Output type	R: relay output
	T: transistor output
	RT: mixed transistor and relay output

Extension BD

Type	Explanation
XP3-3AD2DA-BD2	3 channels 0~10V analog input, 14-bit precision; 2 channels 0~20mA/0~10V analog output, 10-bit precision
XP3-3AD3PT-BD2	3 channels 0~10V analog input, 14-bit precision; 3 channels PT100 thermal resistor input, resolution is 0.1°C, temperature range -100~350°C
XP3-3PT-P-BD2	3 channels PT100 input, PID inside, resolution is 0.1°C, temperature range -100~350°C
XP3-3TC-P-BD2	3 channels K-type thermocouple input, PID inside, resolution is 0.1°C, temperature range 0~970°C
XP-4AD2DA-BD2	4 channels 0~10V analog input, 2 channels 0~20mA/0~10V analog output

1-2. General specification

1-2-1. Product specification

Electrical spec

	Item	Spec
Electrical	Input voltage	AC100V~240V
	Rated frequency	50/60Hz
	Allowable momentary power failure time	Time ≤ 0.5 AC period, interval ≥ 1s
	Withstanding voltage	AC1000V-10mA 1 minute (signal and ground)
	Insulation resistor	About 10MΩ, DC500V (signal and ground)
Environment	Operation temperature	0~50°C
	Storage temperature	-10~60°C
	Ambient humidity	20~85% (no condensation)
	Vibration resistance	10~25Hz (X, Y, Z each direction is 30 minutes 2G)
	Interference immunity	Voltage noise: 1000Vp-p
	Ambient air	No corrosive gas
	Protection	IP20
Structure	Cooling	Natural air cooling
	Dimension	172.0*121.0*56.5 mm
	Installation dimension	164.0*113.0 mm
Interface	Download port	RS-232
	Communication port	RS-485

HMI spec

Item		Spec
Screen	Type	Yellow-green color LCD
	LCD size	3.7 inches
	Use life	20000 hours, 24 hours run under the ambient temperature 25°C
	Display area	192*64
	Contrast	Adjust by potentiometer
	Language	Chinese, English, Spanish, Korean and so on
	Font	Lattice font, vector font
	Touch mode	Untouchable
Memory	Screen	64KB FlashROM
	Data	4KB SRAM

PLC spec

Item		Spec
Program execution mode		Cyclic scan
Programming mode		Instruction, ladder chart, visual C
Operation speed		0.3μs
Latched		FlashROM and Li-battery
User program capacity ^{※1}		128K
I/O points		Input 8 points; output 8 points
Internal coil (M)		8768 points
Flow (S)		1024
Timer (T)	Points	640 points
	Spec	100ms timer: 0.1~3276.7 s
		10ms timer: 0.01~327.67 s 1ms timer: 0.001~32.767 s
Counter (C)	Points	640 points
	Spec	16-bit counter: 0~32767 32-bit counter: -2147483648~+2147483647
Data register (D)		9024 words
FlashROM register (FD)		2048 words
High speed functions		High speed count, pulse output, external interruption
Scheduled scan time		0~99ms
Password protection		6-bit ASCII
Self diagnosis		Power-on self test, monitoring timer, grammar check

※1: the max capacity in encrypting download mode

1-2-2. Special function

1. High speed count

XP3-16 series																			
	Incremental mode										Pulse + direction mode					AB phase mode			
	C600	C602	C604	C606	C608	C610	C612	C614	C616	C618	C620	C622	C624	C626	C628	C630	C632	C634	
Max frequency	10K	10K	10K	10K							10K	10K					5K	5K	
4-time frequency																		√	√
Count interruption	√	√	√	√								√						√	
X000	U										U						A		
X001											Dir						B		
X002		U										U						A	
X003												Dir						B	
X004			U																
X005				U															

2. High speed pulse

- XP3-16T: Y0, max speed is 200 kHz
- XP3-16RT: Y0, max speed is 200 kHz
- XP3-16R: not support

3. External interruption

Input	Pointer		Suppress interruption
	Rising interruption	Falling interruption	
X7	I0100	I0101	M8051
X6	I0200	I0201	M8052

4. Frequency measurement

Type	Input
XP3-16 series	X4、X5







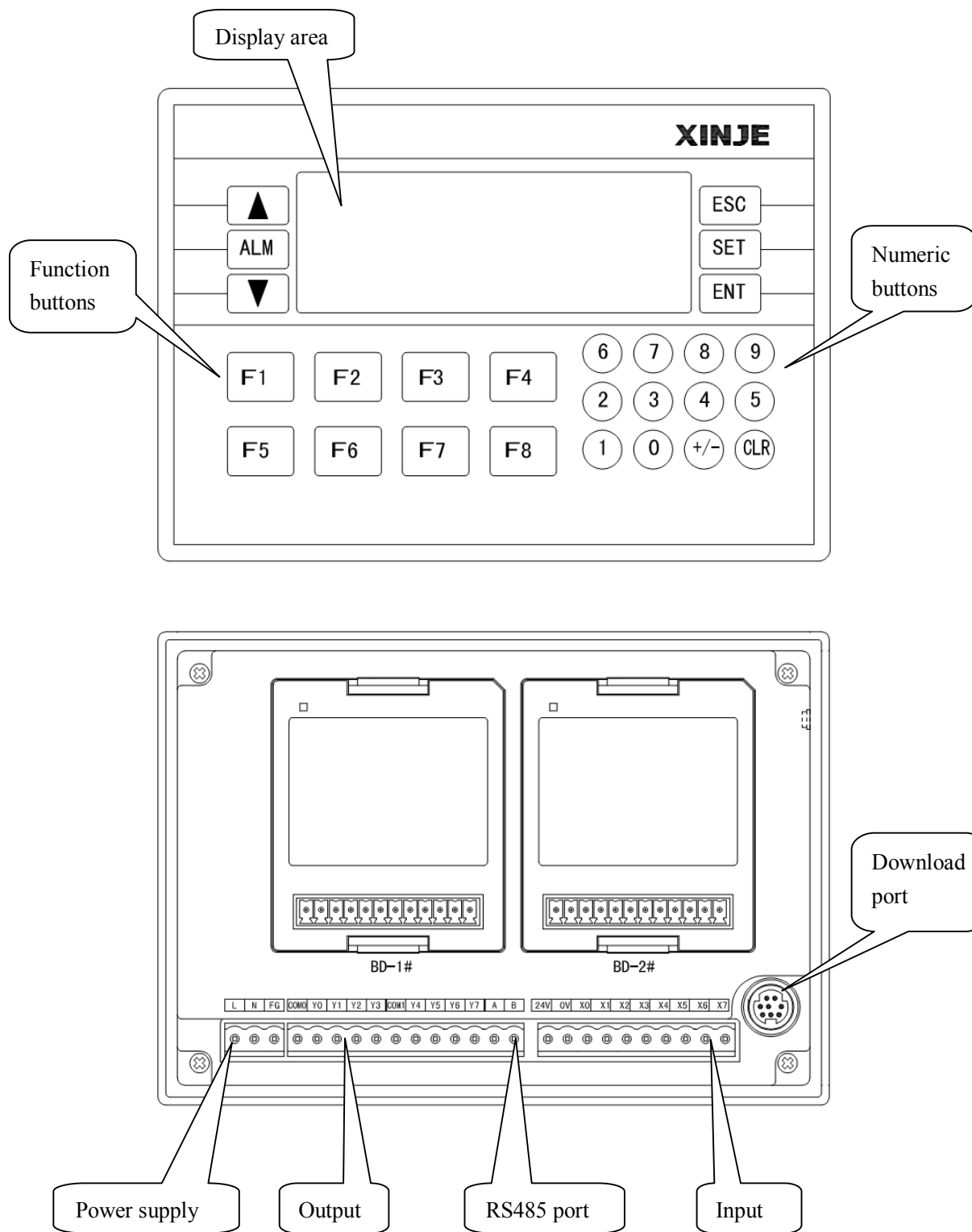



Notes: the details please refer to XC series PLC manual.

1-3. Part introduction

1-3-1. Structure



1-3-2. Function buttons

Button	Function
	Return to initial screen whatever the screen state. Initial screen can be set by user, default is screen 1.
	Front page
	Next page
	Press it to change the register value. Press it again to cancel before pressing [ENT].
	Write the changed data into the register, and continue to change next register.
	Alarm list button. Press it to see the alarm list.
	Clear the data when setting the register
	Set the positive /negative of data
	Numeric button (0~9)
	Function button (F1~F8)

Notes: All the buttons in the above table can be set to other functions including set ON, set OFF, reverse, instant ON.

1-3-3. Terminals

1. Power supply terminals

AC 220V

L
N
FG

2. I/O terminals

L	N	FG	B	COM0	Y0	Y1	Y2	Y3	COM1	Y4	Y5	Y6	Y7	A	B	24V	OV	X0	X1	X2	X3	X4	X5	X6	X7
---	---	----	---	------	----	----	----	----	------	----	----	----	----	---	---	-----	----	----	----	----	----	----	----	----	----

1-3-4. Download and communication port

1. Download port

This port accords with RS232 standard and has double-download function. It can download both PLC and HMI program.

The pin description:

Pin	Function
Pin1	CTS
Pin4	RXD
Pin5	TXD
Pin6	VCC
Pin8	GND

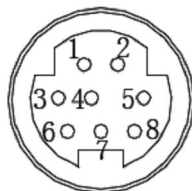

Mini Din 8 pins

Notes:

- (1) Please use the cable supplied by XINJE company
- (2) Do not change the communication parameters (FD8210~8219) of download port, otherwise it cannot download program.

2. Communication port

This port is the RS485 port (terminal A and B) of PLC. It supports Modbus-RTU protocol.

1-4. Dimension

■ Product dimension (unit: mm)

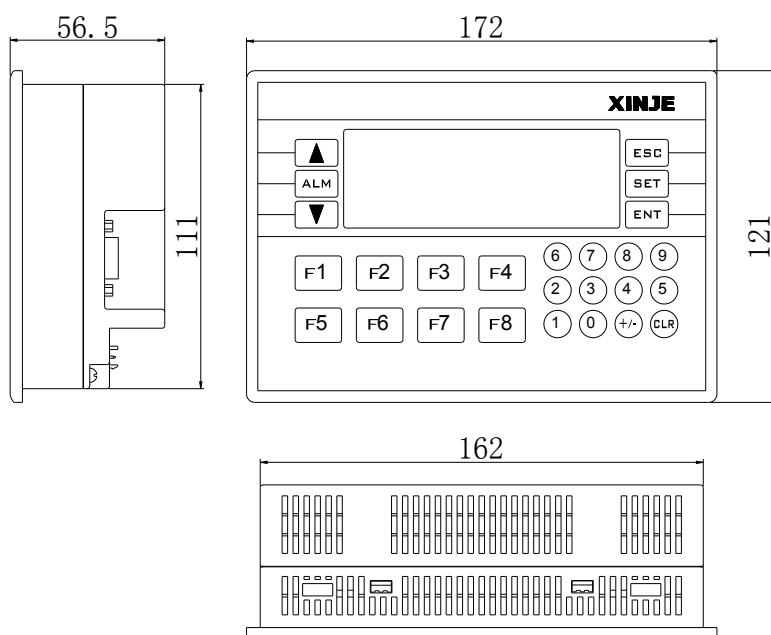

- Open hole dimension (unit: mm)

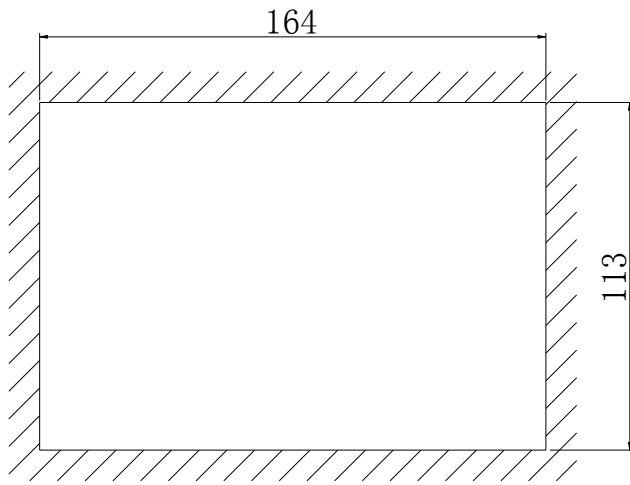

2 I/O and wiring

2-1. Input spec

Basic unit

Input signal voltage	DC24V \pm 10%
Input signal current	7mA/DC24V
Input ON current	Above 4.5mA
Input OFF current	Below 1.5mA
Input response time	About 10ms
Input signal format	Point input or NPN collector open transistor
Circuit insulation	Optical coupling insulation
Input action display	LED is ON when input ON

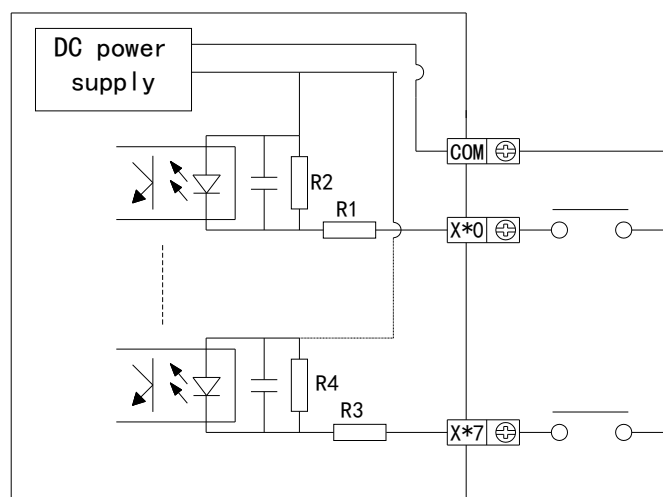

Input wiring

The input current of XP3-16 series is supplied by internal 24V power supply. If using external power supply to drive the optical-electricity sensor, the supplier should be DC24V \pm 4V. The output transistor of sensor should be NPN open collector.

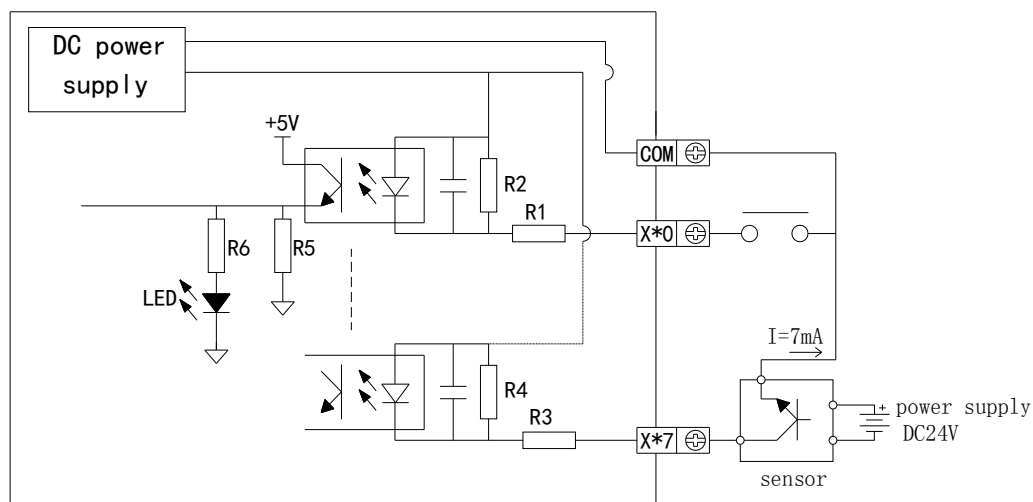

- **Input points**
Connect input point and com point with non-voltage point or NPN open collector transistor to turn on the input.
- **Input loop**
The first loop and the second loop are insulated by optical coupler, the second loop has C-R filter which can prevent wrong action caused by industry noise or input points oscillation. As the result, there will be a response delay for 10ms to the input points. There is digital filter in the input points.
- **Input sensitivity**
Input current is DC 24V 7mA. To make the input reliable, the ON current should be above 3.5mA, the OFF current should be below 1.5mA.

Typical wiring

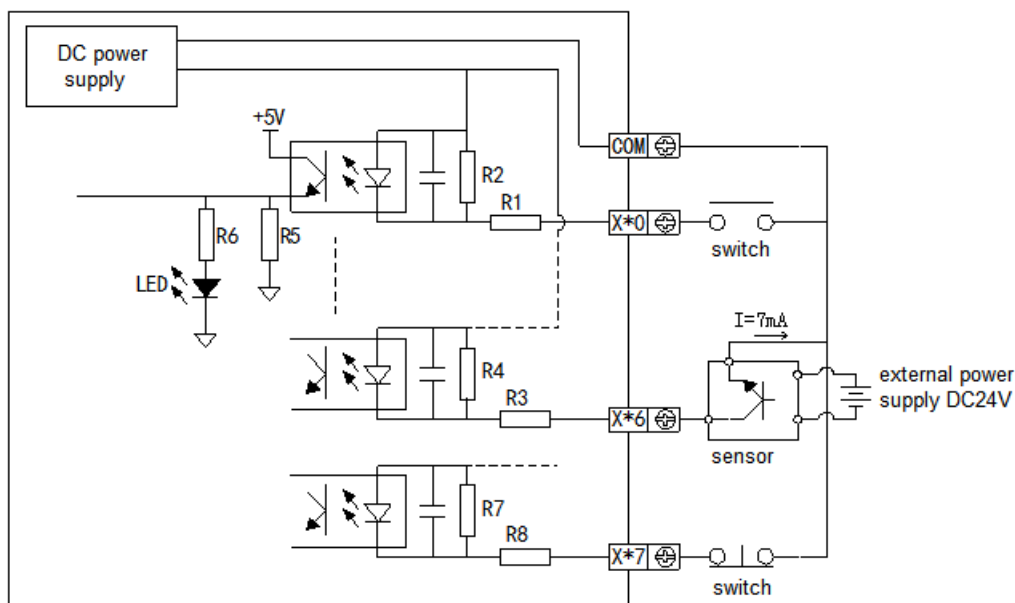

2-2. Relay output

Relay output spec

Power supply		Below AC250V, DC30V
Circuit insulation		Machinery insulation
Max loader	Resistance load	3A
	Inductance load	80VA
	Lamp load	100W
Min loader		DC5V 2mA
Response time	OFF→ON	10ms
	ON→OFF	10ms

Relay output circuit

- Output points
Relay output has two common points. Different units can drive the loader of different power-voltage systems.
- Loop insulation
It is electric insulated between relay output point and outside load circuit.
- Action indication
Relay output coil produces close sound when it is on.
- Response time
The response time is about 10ms transferring the ON or OFF signal from relay output coil to the output connection.
- Output current
Output current is 3A per point to drive resistance load for voltage below AC250V. Inductance load is below 80VA (AC100V or AC200V) and lamp load is below 100W (AC100V or AC200V).
- Open leakage current
There is no leakage current when output point is OFF, it can drive neon light.
- Use life of relay output point
The standard life of inductance load such as contactor, solenoid valve: according to our experiment results, 20VA load is about 3 million times, 35VA load is about 1 million times, 80VA load is about 0.2 million times. However, the life will extend if parallel connect surge absorber with the load.

Typical output wiring

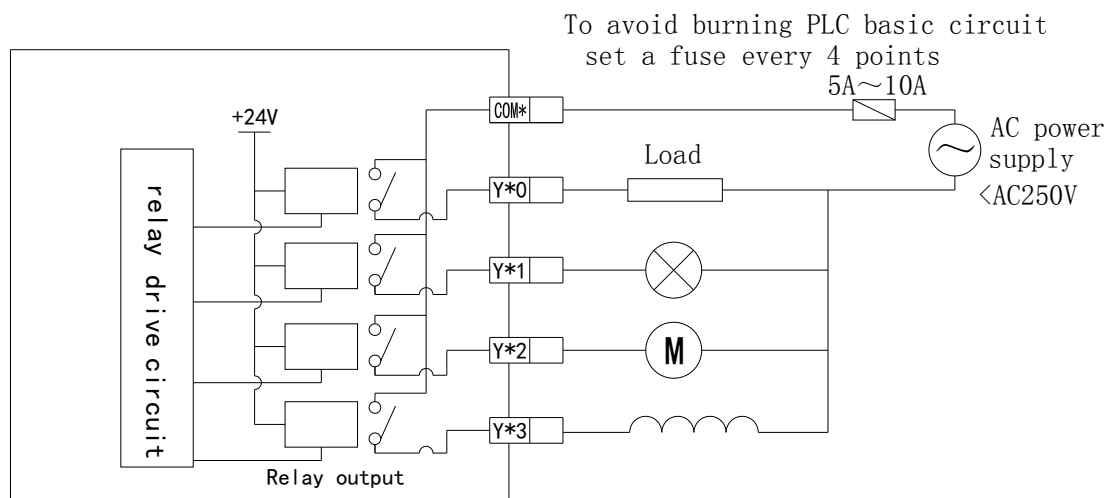

Note: T type has no relay output, do not connect AC220V, or the product will be broken.

Output circuit construction

- ◆ For DC inductance load, please parallel connect with commutate diode. If not connect with the commutate diode, the point's life will be decreased greatly. Please choose the commutate diode which allow inverse voltage endurance up to 5~10 times of the load's voltage, ordinal current exceeds load current.
- ◆ Parallel connect AC inductance load with surge absorber can reduce noise and extend useful life of the points.

DC load

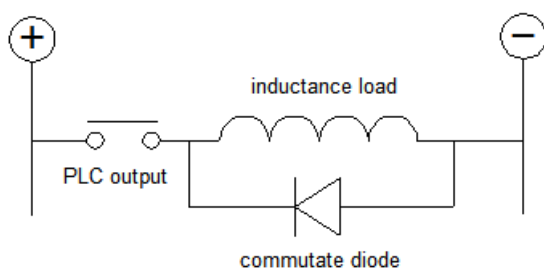

AC load

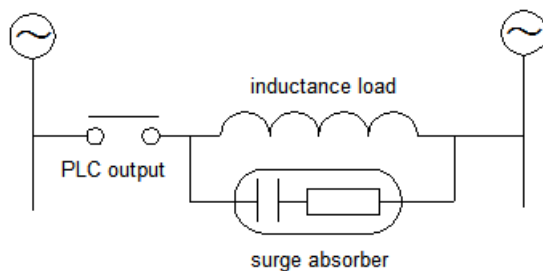

2-3. Transistor output

High speed pulse output

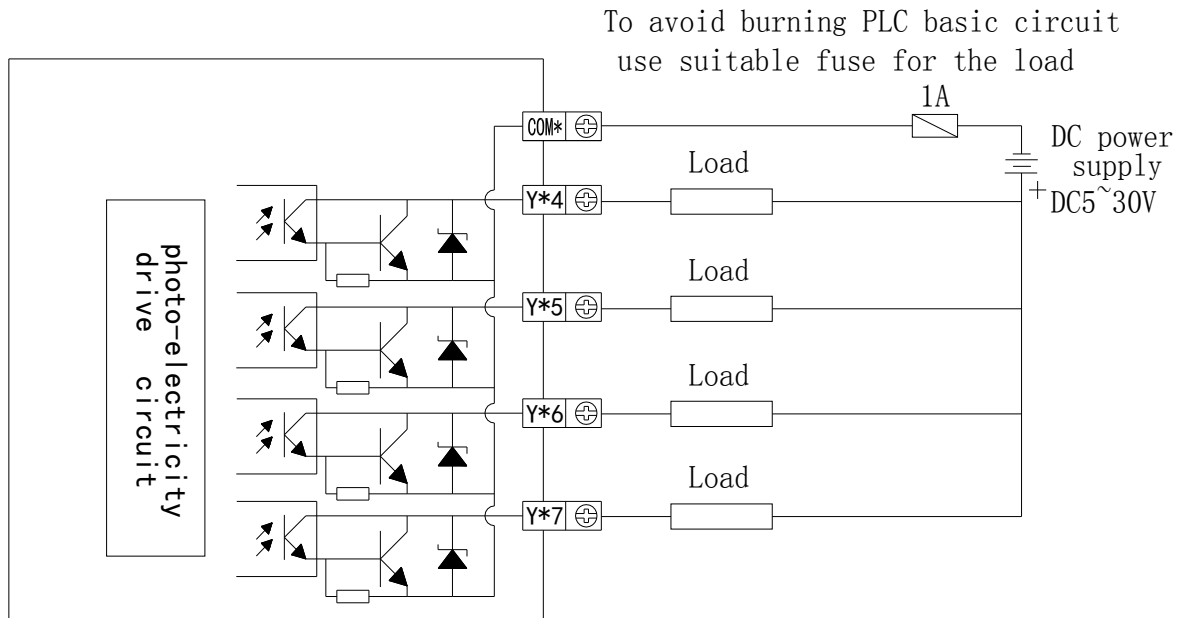

Wiring of pulse output and servo

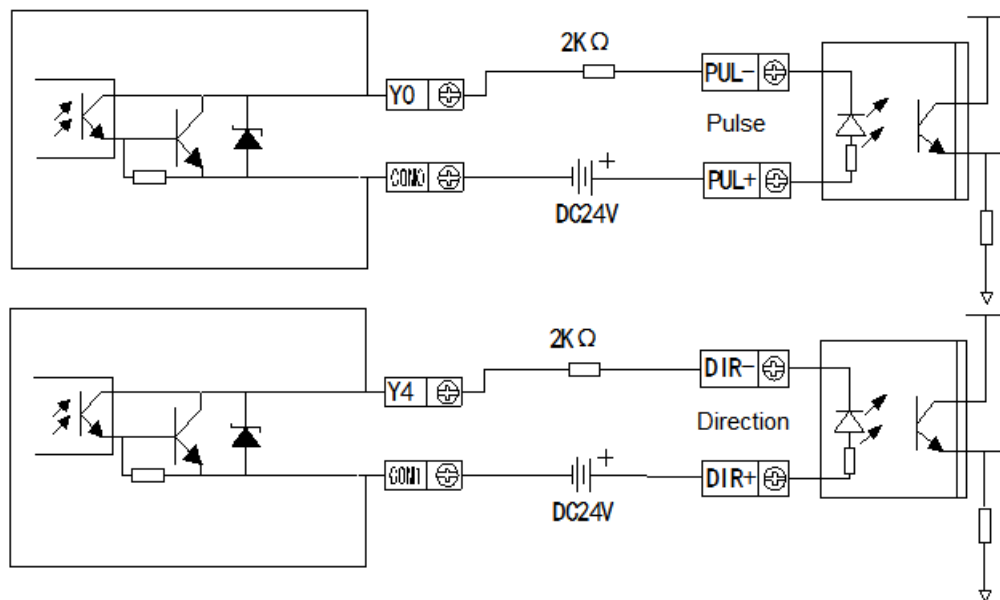

XP3-16

servo drive

Make sure the current of servo drive optical coupling input is 8~15mA.

3 PLC and HMI programming

3-1. PLC programming

1. Please use XCPpro version 3.3 and above.
2. Please change the PLC type to XP3-16 when configure the BD board. If XP3-16 doesn't not connect to BD board, it no need to change the PLC type, the system will indentify the type when downloading the program.

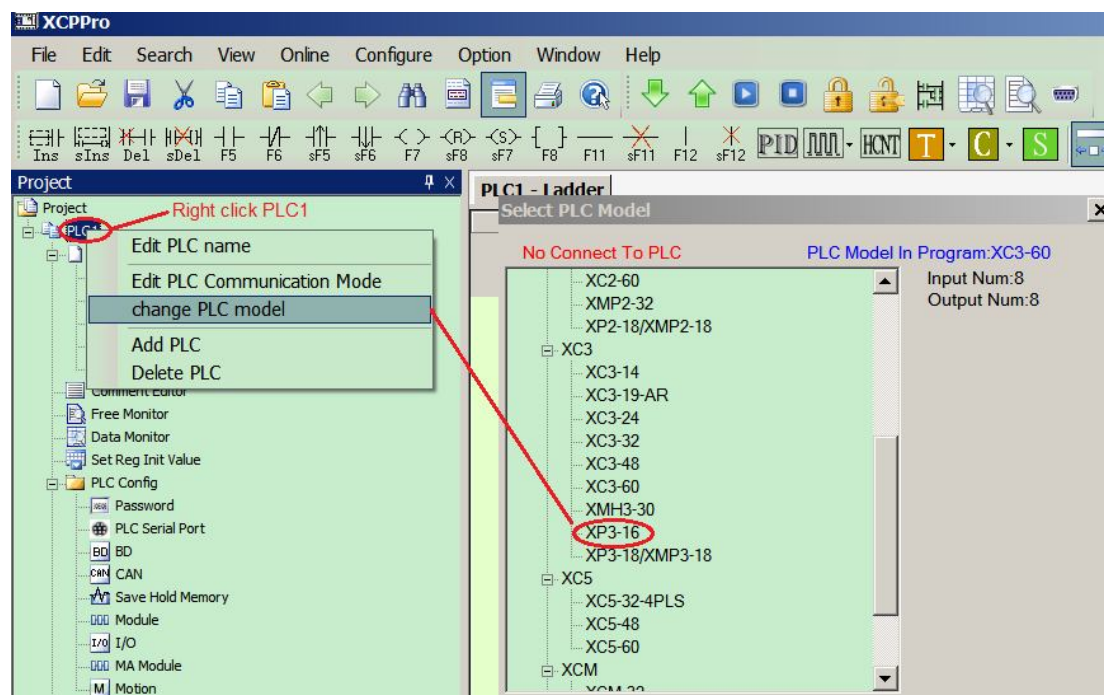

After changing the PLC type, click PLC config/BD, it will show 2 BD boards configuration window:

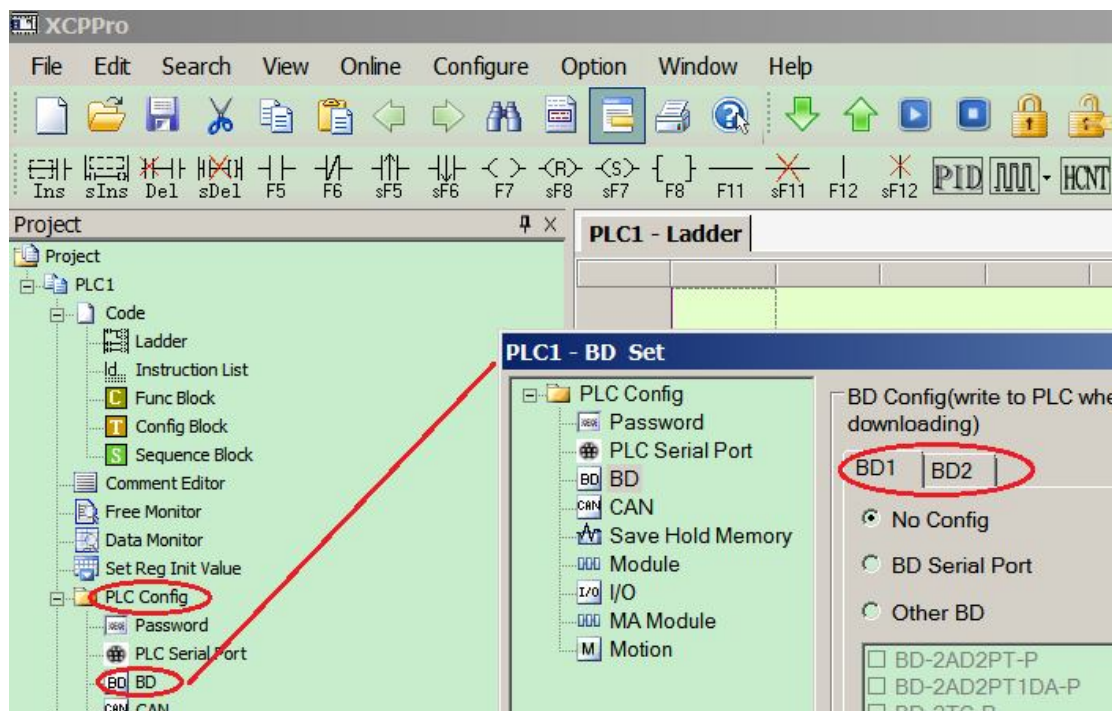

3. XP3-16 series use XP3-xxx-BD2 series BD board. Please distinguish it with other BD boards:
 - (1) XC-xxx-BD: for XC series PLC
 - (2) XP3-xxx-BD: for XP3-18 series integrated PLC&HMI
 - (3) XP3-xxx-BD2: for XP3-16 series integrated PLC&HMI
4. XP3-4AD2DA-BD2 can only install on the left extension place of XP3-16. Others can install on both places. The details please refer to XP3 series extension BD2 board manual.

Notes: for the detailed information of PLC, please refer to XC series PLC manual.

3-2. Instructions

3-2-1. basic instructions

Instruction	Function
LD	Initial logic normally open contactor
LDI	Initial logic normally close contactor
AND	Serial connection normally open contactor
ANI	Serial connection normally close contactor

OR	Parallel connection normally open contactor
ORI	Parallel connection normally close contactor
LDP	Initial logic rising-edge of pulse
LDF	Initial logic falling-edge of pulse
ANDP	Serial connection rising-edge of pulse
ANDF	Serial connection falling-edge of pulse
ORP	Parallel connection rising-edge of pulse
ORF	Parallel connection falling-edge of pulse
LDD	Read normally open contactor
LDDI	Read normally close contactor
ANDD	Read normally open contactor, serial connection
ANDDI	Read normally close contactor, serial connection
ORD	Read normally open contactor, parallel connection
ORDI	Read normally close contactor, parallel connection
OUT	Coil drive
OUTD	Output to the contactor
ORB	Parallel connection of serial circuit block
ANB	Serial connection of parallel circuit block
MCS	New generatrix start
MCR	Generatrix reset
ALT	Negate the coil
PLS	ON for one scanning period at rising-edge of pulse
PLF	ON for one scanning period at falling-edge of pulse
SET	Keep the coil ON

RST	Clear the coil-ON state
TMR	Timer drive
OUT	Counter drive
RST	Reset the contactor, clear the current value
END	Operate output/input and return to step 0
GROUP	Block folding start
GROUPE	Block folding end

3-2-2. Application instructions

Type	Instruction	Function
Process	CJ	Condition jump
	CALL	Call the subprogram
	SRET	Subprogram return
	STL	Process start
	STLE	Process end
	SET	Open assigned process, close current process
	ST	Open assigned process, not close current process
	FOR	Cycle start
	NEXT	Cycle end
	FEND	Main program end
Data comparison	LD=	Initial logic ON when (S1)=(S2)
	LD>	Initial logic ON when (S1)>(S2)
	LD<	Initial logic ON when (S1)<(S2)
	LD<>	Initial logic ON when (S1)≠(S2)

	LD \geq	Initial logic ON when $(S1) \geq (S2)$
	LD \leq	Initial logic ON when $(S1) \leq (S2)$
	AND=	Serial connection ON when $(S1) = (S2)$
	AND $>$	Serial connection ON when $(S1) > (S2)$
	AND $<$	Serial connection ON when $(S1) < (S2)$
	AND \neq	Serial connection ON when $(S1) \neq (S2)$
	AND \geq	Serial connection ON when $(S1) \geq (S2)$
	AND \leq	Serial connection ON when $(S1) \leq (S2)$
	OR=	Parallel connection ON when $(S1) = (S2)$
	OR $>$	Parallel connection ON when $(S1) > (S2)$
	OR $<$	Parallel connection ON when $(S1) < (S2)$
	OR \neq	Parallel connection ON when $(S1) \neq (S2)$
	OR \geq	Parallel connection ON when $(S1) \geq (S2)$
	OR \leq	Parallel connection ON when $(S1) \leq (S2)$
Data transmission	CMP	Data comparison
	ZCP	Data zone comparison
	MOV	Data transmission
	BMOV	Data block transmission
	FMOV	Multi-point repeat transmission
	EMOV	Float transmission
	FWRT	Write into FlashROM
	MSET	Multi-set on
	ZRST	Multi-reset
	SWAP	Exchange the high byte and low byte

	XCH	Exchange two values
Data calculation	ADD	Addition
	SUB	Subtraction
	MUL	Multiplication
	DIV	Division
	INC	Plus one
	DEC	Minus one

Type	Instruction	Function
Data calculation	MEAN	Get the mean value
	WAND	Logic and
	WOR	Logic or
	WXOR	Logic xor
	CML	Negate
	NEG	Negative
Data shift	SHL	Arithmetic shift left
	SHR	Arithmetic shift right
	LSL	Logic shift left
	LSR	Logic shift right
	ROL	Rotate left
	ROR	Rotate right
	SFTL	Bit shift left
	SFTR	Bit shift right
	WSFL	Word shift left

	WSFR	Word shift right
Data conversion	WTD	Word convert to double word
	FLT	16-bit integer convert to float
	FLTD	64-bit integer convert to float
	INT	Float convert to integer
	BIN	BCD convert to binary
	BCD	Binary convert to BCD
	ASCI	Hex convert to ASCII
	HEX	ASCII convert to hex
	DECO	Decoding
	ENCO	High-bit encoding
	ENCOL	Low-bit encoding
	GRY	Binary convert to gray code
	GBIN	Gray code convert to binary
Float calculation	ECMP	Float comparison
	EZCP	Float zone comparison
	EADD	Float addition
	ESUB	Float subtraction
	EMUL	Float multiplication
	EDIV	Float division
	ESQR	Float square
	SIN	Float sine
	COS	Float cosine
	TAN	Float tangent

	ASIN	Float arcsine
	ACOS	Float arccosine
	ATAN	Float arctangent
Clock	TRD	Read clock data
	TWR	Write clock data

3-2-3. Special instructions

Type	Instruction	Function
High-speed count	HSCR	Read 32-bit high-speed counter
	HSCW	Write 32-bit high-speed counter
	OUT	24-segment high-speed count interruption
	RST	High-speed count reset
MODBUS communication	COLR	MODBUS read coil
	INPR	MODBUS read input coil
	COLW	MODBUS write single coil
	MCLW	MODBUS write multi-coil
	REGR	MODBUS read register
	INRR	MODBUS read input register
	REGW	MODBUS write single register
Free format communication	MRGW	MODBUS write multi-register
	SEND	Free format send data
	RCV	Free format receive data
CANBUS	CCOLR	CANBUS read coil

communication	CCOLW	CANBUS write coil
	CREGR	CANBUS read register
	CREGW	CANBUS write register
	CSEND	CAN send
	CRECV	CAN receive

Type	Instruction	Function
Precise timing	STR	Precise timing
	STRR	Read precise timing register
	STRS	Stop precise timing
Interruption	EI	Enable the interruption
	DI	Disable the interruption
	IRET	Interruption return
Sequence block	SBLOCK	Block start
	SBLOCKE	Block end
	BSTOP	Stop the block
	BGOON	Continue running the stop block
	WAIT	Wait
Read &write module	FROM	Read the module
	TO	Write the module
Others	FRQM	Frequency measurement
	PWM	Pulse width modulation
	PID	PID control
	NAME_C	C block

❖ The details please refer to XC series instruction manual.

3-3. HMI programming

The HMI program is edited in OP20 software. Please use the OP20 version 8.0 and above. OP20 is easy to learn and edit. The following we will introduce the programming method.

3-3-1. Make a project



1. Build a project

Open OP20 software, click file/new project or .

2. Select the HMI type

Select OP330 (XP) for XP3-16 series.

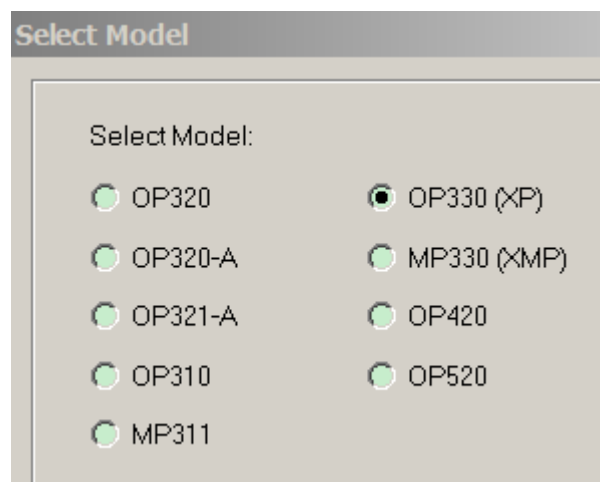

3. Select the PLC type

Select XINJE XC series PLC for XP3-16.

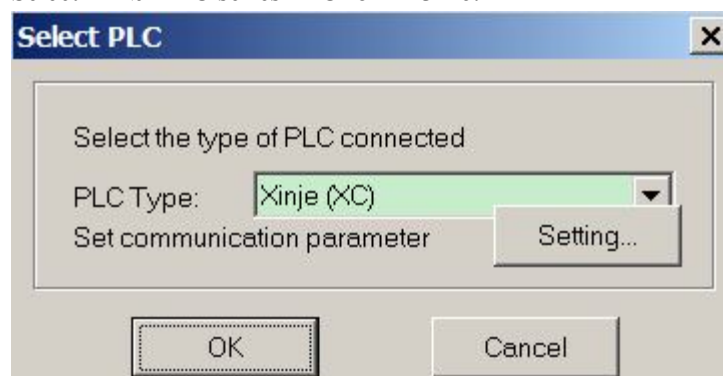

4. Edit the screen

Below is the editing screen. The edit methods please refer to OP series manual.

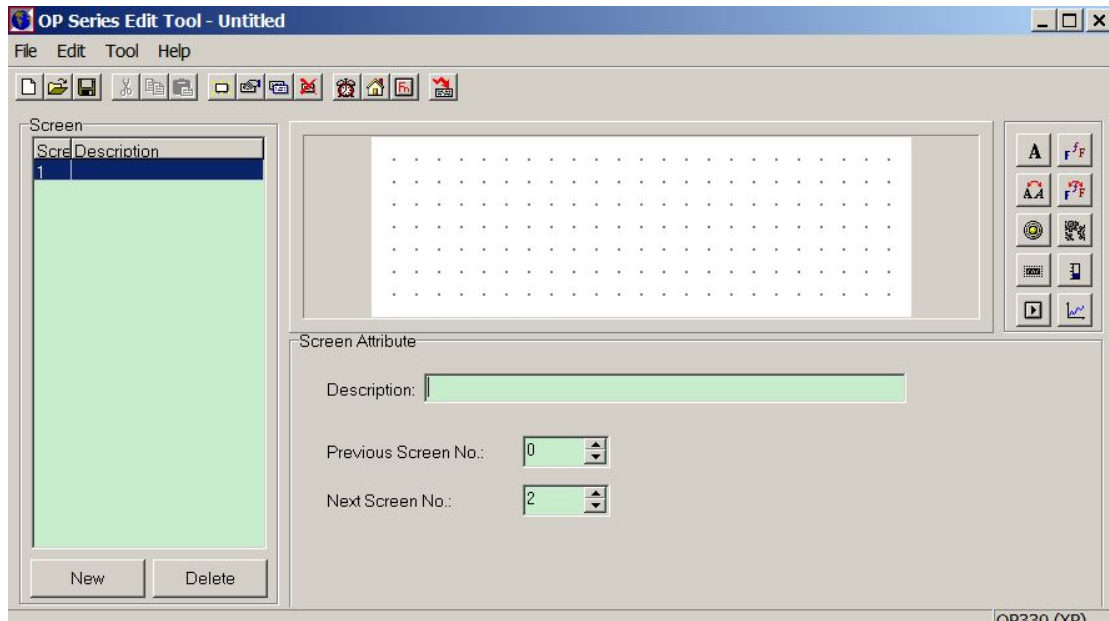

Screen download

1. Select the communication port
Click file/select comm port to select the PC serial port.

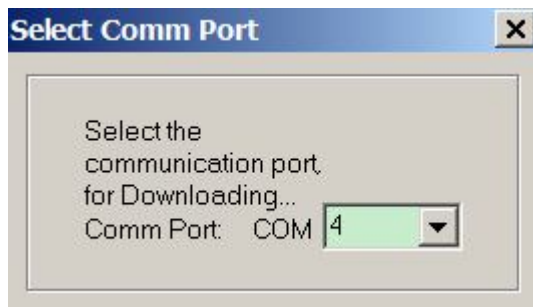

If select the wrong port, it will show below window:

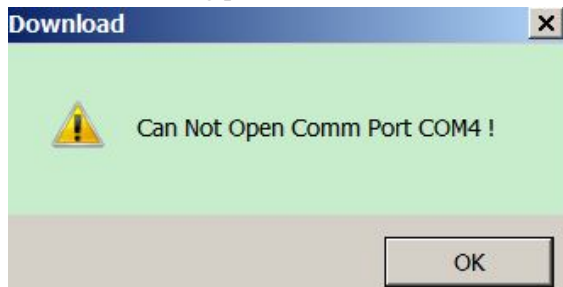

2. Download

Connect PC serial port to XP3-16 with downloading cable. Click  to download.
After finishing the download, it will show download successful window.











Notes:

- (1) Do not cut the power when downloading, or you have to repower on and download again.
- (2) It is the same cable to download PLC and HMI program.





- (3) Do not open XCPpro and OP20 software at the same time when downloading!!





3-3-2. Tools and parts

Tools list

Button	Function
	Build a new project
	Open a project
	Save the project
	Make a new screen
	The property of the screen
	Copy screen
	Delete the screen
	Alarm list
	Set the initial screen, password and control properties
	Set the function button
	Download the program

Part list

Button	Function
	Input text, support multi-language
	Dynamic text, show different text according to the machine state
	Vector text, enable to set the font and size
	Dynamic text, enable to set 254 kinds of states
	Lamp

	Data register input or monitor
	Set the function button
	Insert bmp picture
	Bar diagram, to show the analog quantity such as flow, pressure, liquid level
	Broken line diagram, fit for the data which change slowly

Appendix 1 special auxiliary register

PC status (M8000-M8003)

ID	Function	Description	
M8000	Normally ON coil when running		M8000 keeps being ON status when PLC is running
M8001	Normally OFF coil when running		M8001 keeps being OFF status when PLC is running
M8002	Initial positive pulse coil		M8002 be ON in first scan cycle
M8003	Initial negative pulse coil		M8003 be OFF in first scan cycle

RTC (M8011-M8014)

ID	Function	Description
M8011	Shake with the cycle of 10ms	
M8012	Shake with the cycle of 100ms	
M8013	Shake with the cycle of 10sec	
M8014	Shake with the cycle of 1min	

Flag (M8020-M8029)

ID	Function	Description
M8020	Zero	The plus/minus operation result is 0
M8021	Borrow	“borrow” occurs in minus operation
M8022	Carry	When carry occurs in plus operation or overflow occurs in bit shift operation
M8023		
M8026	RAMP Mode	
M8029		

PC mode (M8030-M8038)

ID	Function	Description
M8030	PLC initializing	
M8031	Non-retentive register reset	When driving this M, ON/OFF mapping memory of Y, M, S, TC and the current values of T, C, D are all reset to be 0
M8032	Retentive register reset	
M8033	Registers keep stopping	When PLC changes from RUN to STOP, leave all content in mapping registers and data registers
M8034	All output forbidden	Set PC's all external contacts to be OFF status
M8038	Parameter setting	Set communication parameters flag

Stepper ladder (M8041-M8046)

ID	Function	Description
M8041		
M8045	All output reset forbidden	When shifting the mode, all outputs reset functions are forbidden
M8046	STL status activate	When M8047 activating, act when any device of S0~S999 turns to be ON

Interruption (M8050-M8059)

ID	Function	Description
M8050 I000□	Forbid the input interruption 0	After executing EI instruction, even the interruption is allowed, but if M acts at this time, the correspond input interruption couldn't act separately E.g.: when M8050 is ON, interrupt I000□ is forbidden
M8051 I010□	Forbid the input interruption 1	
M8052 I020□	Forbid the input interruption 2	
M8053 I030□	Forbid the input interruption 3	
M8054 I040□	Forbid the input interruption 4	
M8055 I050□	Forbid the input interruption 5	
M8056 I40□□	Forbid the time interruption 0	After executing EI instruction, even the interruption is allowed, but if M acts at this time, the correspond time interruption couldn't act separately
M8057 I41□□	Forbid the time interruption 1	
M8058 I42□□	Forbid the time interruption 2	
M8059	Forbid the interruption	Forbid all interruption

Error test (M8067-M8072)

ID	Function	Description
M8067	Operation error	happen when calculating
M8070	Scan time out	
M8071	No user program	Internal codes parity error
M8072	User program error	execution codes or configure table parity error

Communication (M8120-M8148)

	ID	Function	Description
COM1	M8120		
	M8121	Waiting to send via RS232	
	M8122	“sending by RS232” flag	
	M8123	“RS232 receiving finish” flag	
	M8124	RS232 receiving flag	
	M8125	“Receive incomplete” flag	acceptance ends normally, but the accepted data number is less than the required number
	M8126	Global signal	
	M8127	“Accept error” flag	
	M8128	“ Accept correct” flag	
	M8129		
COM2	M8130		
	M8131	Waiting to send via RS232	
	M8132	“sending by RS232” flag	
	M8133	“RS232 receiving finish” flag	
	M8134	RS232 receiving flag	
	M8135	“Receive incomplete” flag	acceptance ends normally, but the accepted data number is less than the required number
	M8136	Global signal	
	M8137	“Accept error” flag	
	M8138	“ Accept correct” flag	
	M8139		
COM3	M8140		
	M8141	Waiting to send via RS232	
	M8142	“sending by RS232” flag	
	M8143	“RS232 receiving finish” flag	
	M8144	RS232 receiving flag	
	M8145	“Receive incomplete” flag	acceptance ends normally, but the accepted data number is less than the required number
	M8146	Global signal	
	M8147	“Accept error” flag	
	M8148	“ Accept correct” flag	
	M8149		

High speed count interruption finished flag (M8150-M 8169)

ID	Counter ID	Function	Description
M8150	C600	“Count Interruption Finished” Flag	Set flag ON when count interruption finish
M8151	C602	“Count Interruption Finished” Flag	Set flag ON when count interruption finish
M8152	C604	“Count Interruption Finished” Flag	Set flag ON when count interruption finish
M8153	C606	“Count Interruption Finished” Flag	Set flag ON when count interruption finish
M8154	C608	“Count Interruption Finished” Flag	Set flag ON when count interruption finish
M8155	C610	“Count Interruption Finished” Flag	Set flag ON when count interruption finish
M8156	C612	“Count Interruption Finished” Flag	Set flag ON when count interruption finish
M8157	C614	“Count Interruption Finished” Flag	Set flag ON when count interruption finish
M8158	C616	“Count Interruption Finished” Flag	Set flag ON when count interruption finish
M8159	C618	“Count Interruption Finished” Flag	Set flag ON when count interruption finish
M8160	C620	“Count Interruption Finished” Flag	Set flag ON when count interruption finish
M8161	C622	“Count Interruption Finished” Flag	Set flag ON when count interruption finish
M8162	C624	“Count Interruption Finished” Flag	Set flag ON when count interruption finish
M8163	C626	“Count Interruption Finished” Flag	Set flag ON when count interruption finish
M8164	C628	“Count Interruption Finished” Flag	Set flag ON when count interruption finish
M8165	C630	“Count Interruption Finished” Flag	Set flag ON when count interruption finish
M8166	C632	“Count Interruption Finished” Flag	Set flag ON when count interruption finish
M8167	C634	“Count Interruption Finished” Flag	Set flag ON when count interruption finish
M8168	C636	“Count Interruption Finished” Flag	Set flag ON when count interruption finish
M8169	C638	“Count Interruption Finished” Flag	Set flag ON when count interruption finish

Pulse output (M8170~M8238)

ID	Pulse ID	Function	specification
M8170	PULSE_1	“sending pulse” flag	Being ON when sending the pulse,
M8171		overflow flag of “32 bits pulse sending”	When overflow, Flag is on
M8172		Direction flag	1 is positive direction, the correspond direction port is on
M8173	PULSE_2	“sending pulse” flag	Being ON when sending the pulse,
M8174		overflow flag of “32 bits pulse sending”	When overflow, Flag is on
M8175		Direction flag	1 is positive direction, the correspond direction port is on
M8176	PULSE_3	“sending pulse” flag	Being ON when sending the pulse,
M8177		overflow flag of “32 bits pulse sending”	When overflow, Flag is on

M8178		Direction flag	1 is positive direction, the correspond direction port is on
M8179	PULSE_4	“sending pulse” flag	Being ON when sending the pulse,
M8180		overflow flag of “32 bits pulse sending”	When overflow, Flag is on
M8181		Direction flag	1 is positive direction, the correspond direction port is on

Absolute, relative bit:

ID	function	specification	
M8190	C600 (24 segments)	1 is absolute, 0 is relative	
M8191	C602 (24 segments)	1 is absolute, 0 is relative	
M8192	C604 (24 segments)	1 is absolute, 0 is relative	
M8193	C606 (24 segments)	1 is absolute, 0 is relative	
M8194	C608 (24 segments)	1 is absolute, 0 is relative	
M8195	C610 (24 segments)	
M8196	C612 (24 segments)		
M8197	C614 (24 segments)		
M8198	C616 (24 segments)		
M8199	C618 (24 segments)		
M8200	C620 (24 segments)		
M8201	C622 (24 segments)		
M8202	C624 (24 segments)		
M8203	C626 (24 segments)		
M8204	C628 (24 segments)		
M8205	C630 (24 segments)		
M8206	C632 (24 segments)		
M8207	C634 (24 segments)		
M8208	C636 (24 segments)		
M8209	C638 (24 segments)		
M8210	Pulse alarm flag (frequency change suddenly)	1 is alarm, 0 is correct	PULSE_1
M8211	Neglect the alarm or not	When flag is 1, stop sending alarm	PULSE_1
M8212	Pulse alarm flag (frequency change suddenly)	1 is alarm, 0 is correct	PULSE_2
M8213	Neglect the alarm or not	When flag is 1, stop sending alarm	PULSE_2
M8214	Pulse alarm flag (frequency change suddenly)	1 is alarm, 0 is correct	PULSE_3
M8215	Neglect the alarm or not	When flag is 1, stop sending alarm	PULSE_3
M8216	Pulse alarm flag (frequency change suddenly)	1 is alarm, 0 is correct	PULSE_4
M8217	Neglect the alarm or not	When flag is 1, stop sending alarm	PULSE_4

M8218	Pulse alarm flag (frequency change suddenly)	1 is alarm, 0 is correct	PULSE_5
M8219	Neglect the alarm or not	When flag is 1, stop sending alarm	PULSE_5

Forward/reverse count

ID	Counter Nr.	Function	Specification
M8238	C300~C498	Positive/negative counter control	0 is increment counter, 1 is decrement counter, default is 0

24 segments HSC interruption loop (M8270~M8289)

ID	Counter ID	Specification	
M8270	24 segments HSC interruption loop (C600)	if set it to be 1, then loop executing the interruption; or else execute only one time interruption;	
M8271	24 segments HSC interruption loop (C602)		
M8272	24 segments HSC interruption loop (C604)		
M8273	24 segments HSC interruption loop (C606)		
M8274	24 segments HSC interruption loop (C608)		
M8275	24 segments HSC interruption loop (C610)		
M8276	24 segments HSC interruption loop (C612)		
M8277	24 segments HSC interruption loop (C614)		
.....		
M8279	24 segments HSC interruption loop (C618)		
M8280	24 segments HSC interruption loop (C620)	if set it to be 1, then loop executing the interruption; or else execute only one time interruption;	
M8281	24 segments HSC interruption loop (C622)		
.....		

M8284	24 segments HSC interruption loop (C628)		
M8285	24 segments HSC interruption loop (C630)	if set it to be 1, then loop executing the interruption; or else execute only one time interruption;	
.....		
M8289	24 segments HSC interruption loop (C638)		

Read & write the module (M8340~M8341)

ID	Function	Specification
M8340	Read the expansion error flag (read instruction)	
M8341	Write the expansion error flag (write instruction)	

BLOCK execution (M8630~M8730)

ID	Function	Specification
M8630		
M8631	BLOCK1 is running flag	
M8632	BLOCK2 is running flag	
.....
.....
.....
M8730	BLOCK100 is running flag	

Appendix 2 Special data register

RTC (D8010-D8019)

ID	Function	Specification
D8010	The current scan cycle	Unit:0.1ms
D8011	The min. scan time	Unit:0.1ms
D8012	The max. scan time	Unit:0.1ms
D8013	Second (clock)	0~59 (BCD code)
D8014	minute (clock)	0~59 (BCD code)
D8015	hour (clock)	0~23 (BCD code)
D8016	day (clock)	0~31 (BCD code)
D8017	month (clock)	0~12 (BCD code)
D8018	year (clock)	2000~2099 (BCD code)
D8019	week (clock)	0 (Sunday)~6 (Saturday) (BCD code)

Error check (D8067-D8098)

ID	Function	Specification
D8067	Operation error code's Nr.	The error of divide zero
D8068	lock the Nr. of error code	
D8069		
D8070	exceeded scan time	Unit 1ms
D8074	Nr. of offset registers D	
D8097		
D8098		

Communication (D8120-D8149)

	ID	Function	specification
Com 1	D8120		
	D8121		
	D8122	the left data RS232 should send	
	D8123	Data number RS232 received	
	D8126		
	D8127	Communication error code	7: hardware error 8: CRC Parity error 9: station number error 10: no start code 11: no end code 12: communication time out
	D8128	Modbus communication error (the replied message from slaves when the master send errors)	0: correct 1: don't support function ID 2: address error (overrun address) 3: Data error (the number of data) 8: saving data error (rewrite Flash)
D8129			
Com2	D8130		
	D8131		
	D8132	the left data RS232 should send	
	D8133	Data number RS232 received	
	D8136		
	D8137	Communication error code	7: hardware error 8: CRC check error 9: station number error 10: no start sign 11: no end sign 12: communication time out
	D8138	Modbus communication error (the replied message from slaves when the master send errors)	0: correct 1: don't support function ID 2: address error(overrun address) 3: Data error (the number of data) 8: saving data error (rewrite Flash)
D8139			
Com 3	D8140		
	D8141		
	D8142	the left data RS232 should send	
	D8143	Data number RS232 received	
	D8146		

	D8147	Communication error code	7: hardware error 8: CRC check error 9: station number error 10: no start sign 11: no end sign 12: communication time out
	D8148	Modbus communication error (the replied message from slaves when the master send errors)	0: correct 1: don't support function ID 2: address error(overrun address) 3: Data error (the number of data) 8: saving data error (rewrite Flash)
	D8149		

HSC interruption state (D8150-D8169)

ID	Counter ID	function	specification
D8150	C600	The current segment (No.n segment)	
D8151	C602	The current segment	
D8152	C604	The current segment	
D8153	C606	The current segment	
D8154	C608	The current segment	
D8155	C610	The current segment	
D8156	C612	The current segment	
D8157	C614	The current segment	
D8158	C616	The current segment	
D8159	C618	The current segment	
D8160	C620	The current segment	
D8161	C622	The current segment	
D8162	C624	The current segment	
D8163	C626	The current segment	
D8164	C628	The current segment	
D8165	C630	The current segment	
D8166	C632	The current segment	
D8167	C634	The current segment	
D8168	C636	The current segment	
D8169	C638	The current segment	

Pulse output (D8170-D8220)

ID	Pulse ID	function	specification
D8170	PULSE_1	The low 16 bits of accumulated pulse number	
D8171		The high 16 bits of accumulated pulse number	
D8172		The current segment (means Nr.n segment)	
D8173	PULSE_2	The low 16 bits of accumulated pulse number	
D8174		The high 16 bits of accumulated pulse number	
D8175		The current segment (means Nr.n segment)	
D8176	PULSE_3	The low 16 bits of accumulated pulse number	Only XC5-32RT-E (4PLS) model has
D8177		The high 16 bits of accumulated pulse number	
D8178		The current segment (means Nr.n segment)	
D8179	PULSE_4	The low 16 bits of accumulated pulse number	
D8180		The high 16 bits of accumulated pulse number	
D8181		The current segment (means Nr.n segment)	
D8190	PULSE_1	The low 16 bits of the current accumulated current pulse number	
D8191		The high 16 bits of the current accumulated current pulse number	
D8192	PULSE_2	The low 16 bits of the current accumulated current pulse number	
D8193		The high 16 bits of the current accumulated current pulse number	
D8194	PULSE_3	The low 16 bits of the current accumulated current pulse number	Only XC5-32RT-E (4PLS) model has
D8195		The high 16 bits of the current accumulated current pulse number	
D8196	PULSE_4	The low 16 bits of the current accumulated current pulse number	
D8197		The high 16 bits of the current accumulated current pulse number	

ID	Pulse ID	Function	Description
D8210	PULSE_1	Error segment number	PULSE_1
D8212	PULSE_2	Error segment number	PULSE_2

D8214	PULSE_3	Error segment number	PULSE_3
D8216	PULSE_4	Error segment number	PULSE_4
D8218	PULSE_5	Error segment number	PULSE_5
D8220	Frequency Testing Precision	indicate the bit Nr. Behind the decimal dot, 1 means *10, 2 means *100	

Absolute positioning/relative positioning/origin returning (D8230-D8239)

ID	Pulse	Function	Description
D8230	PULSE_1	Rising time of the absolute/relation position instruction (Y0)	
D8231		Falling time of the origin return instruction (Y0)	
D8232	PULSE_2	Rising time of the absolute/relation position instruction (Y1)	
D8233		Falling time of the origin return instruction (Y1)	
D8234	PULSE_3	Rising time of the absolute/relation position instruction (Y2)	
D8235		Falling time of the origin return instruction (Y2)	
D8236	PULSE_4	Rising time of the absolute/relation position instruction (Y3)	
D8237		Falling time of the origin return instruction (Y3)	
D8238	PULSE_5	Rising time of the absolute/relation position instruction	
D8239		Falling time of the origin return instruction	

Read & write the module (D8315-D8316)

ID	Function	Description
D8315	Read the expansion's error type	
D8316	Write the expansion's error type	

Sequential function BLOCK (D8630-D8730)

ID	Function	Description
D8630		
D8631	The current executing instruction of BLOCK1	The value is used when BLOCK is monitoring
D8632	The current executing instruction of BLOCK2	The value is used when BLOCK is monitoring
.....

.....
.....
D8730	The current executing instruction of BLOCK100	The value is used when BLOCK is monitoring

Error message of module (D8600-D8627)

ID	Function	specification	Expansion ID
D8600	Read the expansion's error times		Expansion 1
D8601	Read the expansion's error	1. expansion's CRC parity error 2. expansion's address error 3. expansion's accepted data length error 4. expansion's accept buffer zone overflow 5. expansion's timeout error 6. CRC parity error when PLC is accepting data 7. unknown error	
D8602	write the expansion's error times		
D8603	write the expansion's error	Expansion 2
D8604	Read the expansion's times		
D8605	Read the expansion's error	
D8606	write the expansion's error times		Expansion 3
D8607	write the expansion's error	
D8608	Read the expansion's times		
D8609	Read the expansion's error	Expansion 4
D8610	write the expansion's error times		
D8611	write the expansion's error	
D8612	Read the expansion's times		Expansion 4
D8613	Read the expansion's error	
D8614	write the expansion's error times		
D8615	write the expansion's error	Expansion 7
.....	
.....	
D8624	Read the expansion's times		Expansion 7
D8625	Read the expansion's error	
D8626	write the expansion's error times		

D8627	write the expansion's error	
-------	-----------------------------	-------	--

Appendix 3 Special Flash register

1. I filter

ID	Function	Initial Value	Description
FD8000	input filter time of X port	10	Unit: ms
FD8002		0	
FD8003		0	
.....		0	
FD8009		0	

2. I mapping

ID	Function	Initial value	Description
FD8010	X00 corresponds with I**	0	X0 corresponds with number of input image I**
FD8011	X01 corresponds with I**	1	Initial values are all decimal
FD8012	X02 corresponds with I**	2	
.....		
FD8073	X77 corresponds with I**	63	

3. O mapping

ID	Function	Initial value	Description
FD8074	Y00 corresponds with I**	0	Y0 corresponds with the number of output image O**
FD8075	Y01 corresponds with I**	1	Initial value are all decimal
FD8076	Y02 corresponds with I**	2	
.....		
FD8137	Y77 corresponds with I**	63	

4. I property

ID	function	Initial value	Description
FD8138	X00 property	all be 0	0: positive logic; others: negative logic
FD8139	X01 property		
FD8140	X02 property		
.....		
FD8201	X77 property		

5. power-off retentive area of soft components

ID	Function	Initial Value
FD8202	Start tag of D power off retentive area	4000
FD8203	Start tag of M power off retentive area	3000
FD8204	Start tag of T power off retentive area	640
FD8205	Start tag of C power off retentive area	320
FD8206	Start tag of S power off retentive area	512
FD8207	Start tag of ED power off retentive area	0
FD8209	Pulse director and pulse delay time setting	50ms

6. Communication

	ID	Function	Initial	Description
COM1	FD8210	Communicate Mode (station number)	1	255 (FF) is free mode, 1~254 is modbus station number
	FD8211	Communicate format	8710	Baud rate, Data bit, stop bit, parity
	FD8212	Judgment time of ASC timeout	3	Unit ms, if set to be 0, it means no timeout waiting
	FD8213	Judgment time of reply timeout	300	Unit ms, if set to be 0, it means no timeout waiting
	FD8214	Start ASC	0	High 8 bits invalid
	FD8215	End ASC	0	High 8 bits invalid
	FD8216	Free format setting	0	8/16 bits buffer; With/without start bit, With/without stop bit
COM2	FD8220	Communicate Mode (station number)	8710	255 (FF) is free mode, 1~254 is modbus station number
	FD8221	Communicate format	3	Baud rate, Data bit, stop bit, parity
	FD8222	Judgment time of ASC timeout	300	Unit ms, if set to be 0, it means no timeout waiting
	FD8223	Judgment time of reply timeout	0	Unit ms, if set to be 0, it means no timeout waiting
	FD8224	Start ASC	0	High 8 bits invalid
	FD8225	End ASC	0	High 8 bits invalid
FD8226	Free format setting	8710	8/16 bits buffer; With/without start bit, With/without stop bit	
COM3	FD8230	Communicate Mode (station number)	8710	255 (FF) is free mode, 1~254 is modbus station number
	FD8231	Communicate format	3	Baud rate, Data bit, stop bit, parity

	FD8232	Judgment time of ASC timeout	300	Unit ms, if set to be 0, it means no timeout waiting
	FD8233	Judgment time of reply timeout	0	Unit ms, if set to be 0, it means no timeout waiting
	FD8234	Start ASC	0	High 8 bits invalid
	FD8235	End ASC	0	High 8 bits invalid
	FD8236	Free format setting	8710	8/16 bits buffer; With/without start bit, With/without stop bit

7. Subsection Power-off Retentive Zone of Timer T

Nr.	Function	Initial Value
FD8323	Set the retentive zone's start tag of 100ms non-accumulation timer	
FD8324	Set the retentive zone's start tag of 100ms accumulation timer	
FD8325	Set the retentive zone's start tag of 10ms non-accumulation timer	
FD8326	Set the retentive zone's start tag of 10ms accumulation timer	
FD8327	Set the retentive zone's start tag of 1ms non-accumulation timer	
FD8328	Set the retentive zone's start tag of 1ms accumulation timer	
FD8329	Set the retentive zone's start tag of 1ms precise timer	

8. Subsection power-off retentive zone of counter C

Nr.	Function	Initial Value
FD8330	Set the retentive zone's start tag of 16 bits positive counter	
FD8331	Set the retentive zone's start tag of 32 bits positive/negative counter	
FD8332	Set the retentive zone's start tag of single-phase HSC	
FD8333	Set the retentive zone's start tag of dual-phase HSC	
FD8334	Set the retentive zone's start tag of AB-phase HSC	

※1: If you change special FLASH memory, it will take into effect after restart the PLC

XINJE

Xinje Electronic Co., Ltd.

4th Floor Building 7,Originality Industry park,
Liyuan Development Zone, Wuxi City, Jiangsu
Province 214072

Tel: (510) 85134136

Fax: (510) 85111290

www.xinje.com